

M12 male 0° X-cod. / RJ45 male 0° Gigabit

TPE 4x2x26AWG SF/UTP CAT6a bu UL/CSA, CMR 10m

Ethernet CAT6A

Plastic housings with good resistance against chemicals and oils.

Male straight – male straight

M12 – RJ45, 8-pole

X-coded

without cable sleeves

shielded

Protection cap

Transmission properties with channel transmission up to 50 m

Further cable lengths on request.

[Link to Product](#)

Illustration

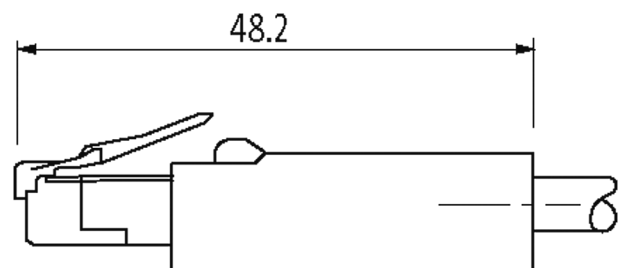
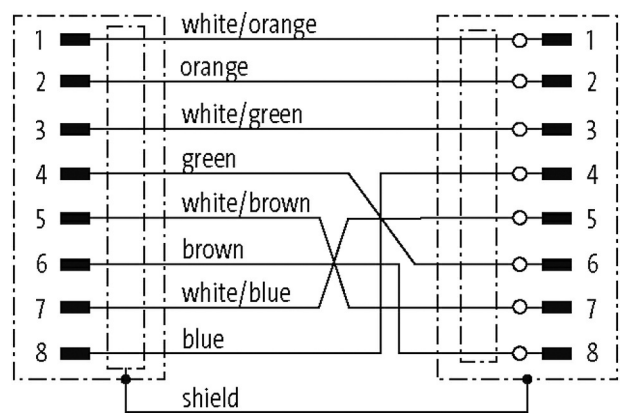
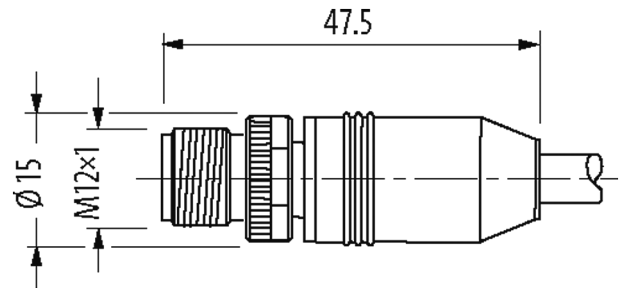

Product may differ from Image

Approvals



* only for products with UL/CSA approved cable

More Info



EtherNet/IP

Form

Form

51101

General data

Standards	DIN EN 61076-2-109 (M12)
Mounting method	inserted, tightened
Pollution Degree	3
Temperature range	-25...+85 °C, depending on cable quality

Cables

Cable number	S4X
No./diameter of wires	4 × 2 × 0.14 mm ²
Wire isolation	HDPE (whbl, bl, whor, or, whgn, gn, whbr, br)
C-track properties	1 Mio.
Jacket Color	blue
Material (jacket)	TPE (UL/CSA)
Outer Ø	7.4 mm ±5%
Bend radius (moving)	10 × outer Ø
Temperature range (fixed)	-40...+80 °C
Temperature range (mobile)	-20...+80 °C
Cable identification	S4X
Approval (cable)	UL (AWM-Style 2463/11547), CSA
Cable weight [g/m]	65,48
Material (wire)	Cu wire, tin plated
Resistor (core)	max. 140 Ohm/km
Single wire Ø (core)	0.16 mm
Construction (core)	7 × 0.16 mm
Diameter (core)	4 × 2 × 0.14 mm ²
Material (wire isolation)	HDPE
Wire-Ø incl. isolation	0.9 mm ±5%
Color/numbering of wires	(wh-bl, bl) + (wh-or, or) + (wh-gn, gn) + (wh-br, br)
Shield	yes
	min. 75%
Material (jacket)	TPE
Outer-Ø (jacket)	7.4 mm ±5%
thermal resistance	flame retardant
Nominal voltage	600 V
Test voltage	max. 1.5 kV AC (2s)
Temperature range (fixed)	-40...+80 °C
Temperature range (mobile)	-20...+80 °C
Bend radius (fixed)	5 × outer Ø
Bend radius (moving)	10 × outer Ø
No. of bending cycles (C-track)	max. 10 Mio. (25 °C)
Traversing distance (C-track)	max. 0.6 m
Travel speed (C-track)	max. 1.2 m/s
Acceleration (C-track)	max. 2.4 m/s ²
No. of torsion cycles	max. 3 Mio. (25 °C)
Torsion speed	60 cycles/min
	max. 1000 mOhm/m @ 100 MHz
	max. 280 Ohm/km
	100 Ohm @ 100 MHz

Technical Data

Operating voltage	max. 60 V DC
-------------------	--------------

Operating voltage (only UL listed)	30 V DC
Rated surge voltage	1.0 kV
Operating current per contact	max. 0.5 A
Material group	IEC 60664-1, category I
No. of poles	8
Transfer parameters	CAT6, Class EA (ISO/IEC 11801:2002), (EN 50173-1)
Transfer rate	10 Gbit/s
Coding	M12, X-coded
LED display	no
Locking of ports	Screw thread (M12×1 mm) recommended torque 0.6 Nm, self-securing
Compression gland	M12 (SW13)
Protection	IP66K, IP67 (M12) - IP20 (RJ45)
Locking material	Zinc die casting, matte nickel plated (M12)
Material	PUR
suitable for corrugated tube (internal Ø)	without

Commercial data

country of origin	DE
customs tariff number	85444290
EAN	4048879688215
eClass	27061801
Packaging unit	1

Sketch

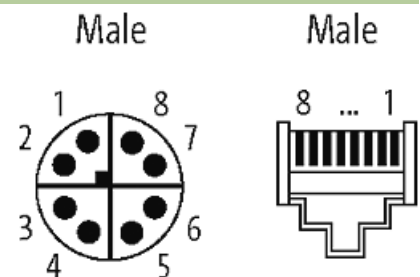

Product may differ from Image